

RESERVDELSKATALOG

: JONSERED

Reservdelslista

RESERVDELSLISTA

D

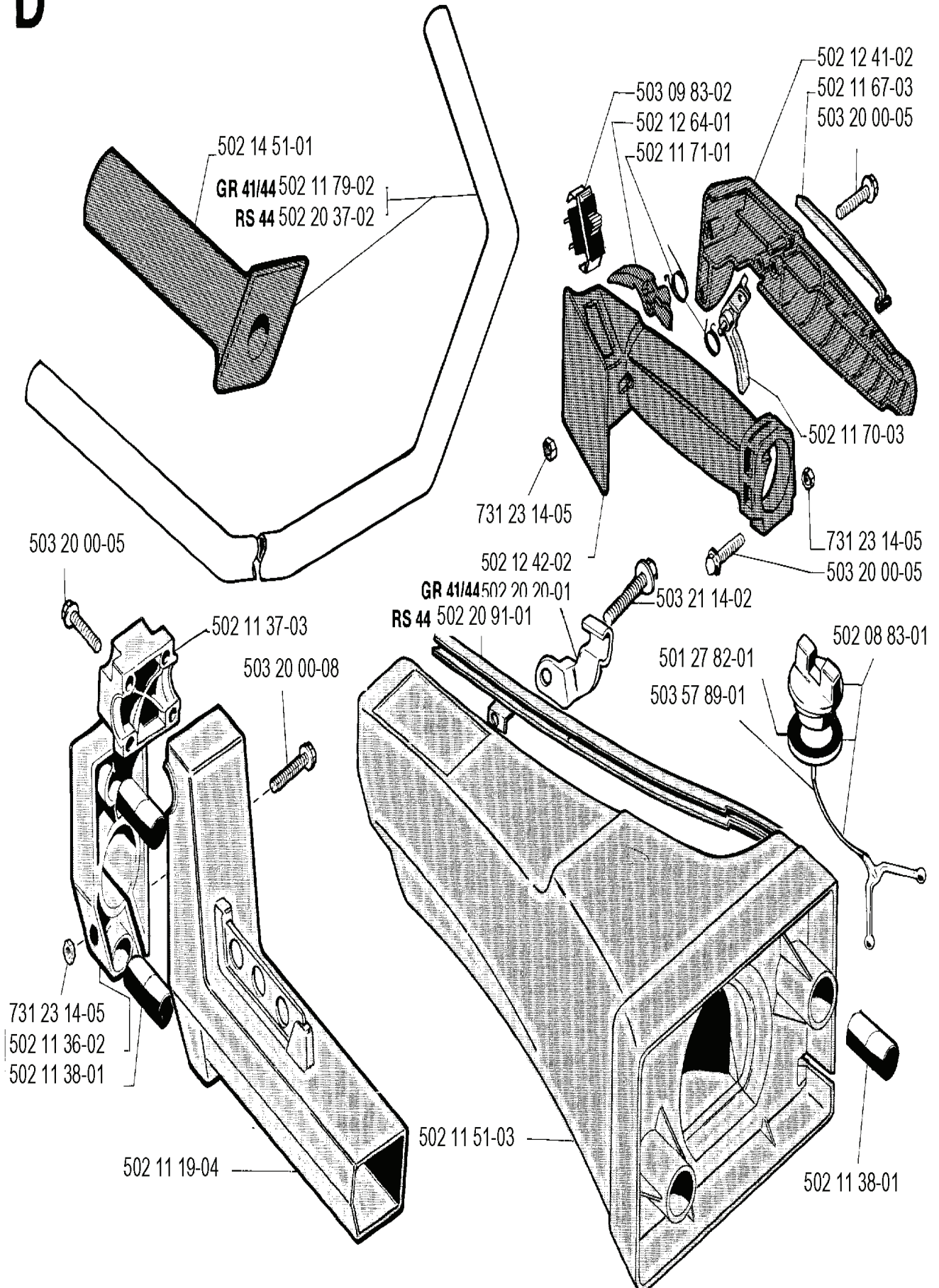

REF.	ART. NR	ARTIKELBESKRIVNING	ANMÄRKNING	KIT
502 14 51-01	502145101	HANDTAG		1
502 11 79-02	502117902	HANDLEBAR	GR 41/44	1
502 20 37-02	502203702	HANDLEBAR	RS 44	1
502 11 36-02	502113602	HÅLLARE		1
502 11 38-01	502113801	VIBRATIONISOLATOR		1
502 11 19-04	502111904	UPPHÄNGNING		1
503 20 00-08	503200008	SKRUV EHHFM		1
502 11 37-03	502113703	STYRHÅLLARE		1
502 11 51-03	502115103	BRÄNSLETANK KPL		1
502 20 91-01	502209101	KÅPA	RS 44	1
502 20 20-01	502202001	KABELHÅLLARE	GR 41/44	1
502 12 42-02	502124202	HANDTAGSHALVA		1
503 21 14-02	503211402	SKRUV EHHFT		1
501 27 82-01	501278201	PACKNING		1
503 57 89-01	503578901	HÅLLARE		1
502 08 83-01	502088301	TANKLOCK KPL		1
731 23 14-05	731231405	MUTTER (HEXAGON)		1
502 11 70-03	502117003	THROTTLE TRIGGER		1
503 20 00-05	503200005	SKRUV EHHFM		1
502 11 67-03	502116703	GASSPÄRR		1
502 12 41-02	502124102	HANDTAGSHALVA		1
502 11 71-01	502117101	RETURFJÄDER		1
502 12 64-01	502126401	HÄVARM		1
503 09 83-02	503098302	STOPPKONTAKT		1

E

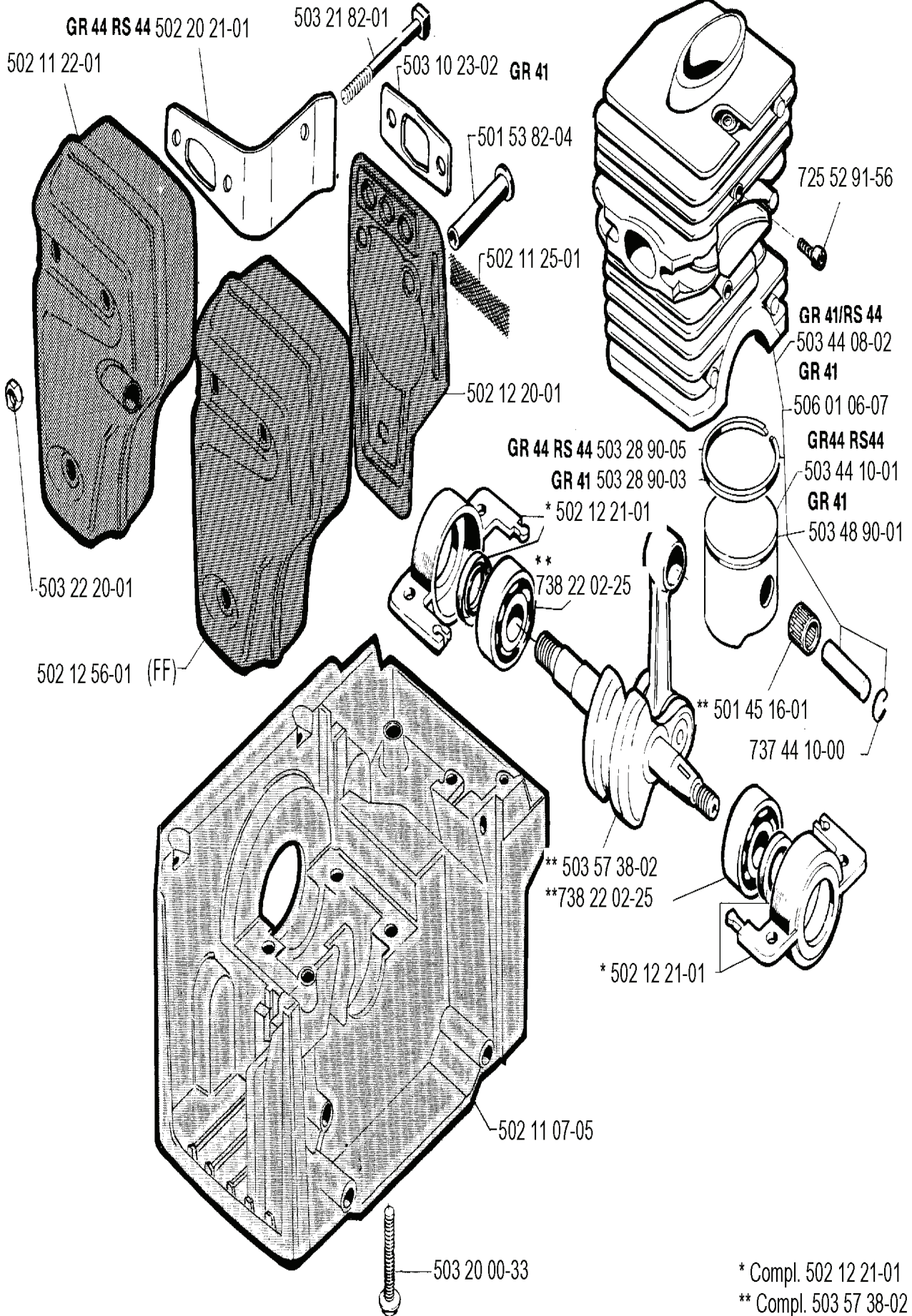

* Compl. 502 12 21-01
** Compl. 503 57 38-02

REF.	ART. NR	ARTIKELBESKRIVNING	ANMÄRKNING	KIT
502 20 21-01	502202101	VÄRMEAVLEDARE	GR 44 RS 44	1
502 11 22-01	502112201	LJUDDÄMPARE KPL		1
503 22 20-01	503222001	LOCK NUT		1
502 12 56-01	502125601	LJUDDÄMPARE KPL	FF	1
503 20 00-33	503200033	SKRUV EHHFM		1
502 11 07-05	502110705	VEVHUS		1
503 21 82-01	503218201	SCREW		1
503 10 23-02	503102302	GASKET MUFFLER	GR 41	1
501 53 82-04	501538204	DISTANSRÖR		1
502 11 25-01	502112501	GNISTFÅNGARNÄT		1
502 12 20-01	502122001	SKYDDSPÅLÅT		1
503 28 90-05	503289005	KOLVRING	GR 44 RS 44	1
503 28 90-03	503289003	KOLVRING	GR 41	1
503 57 38-02	503573802	VEVAXEL KPL		1
738 22 02-25	738220225	KULLAGER		1
502 12 21-01	502122101	AXELSÅTE		1
737 44 10-00	737441000	LÅSRING		1
501 45 16-01	501451601	NÅLLAGER		1
503 48 90-01	503489001	KOLV KPL	GR 41	1
503 44 10-01	503441002	KOLV KPL	GR44 RS44	1
506 01 06-07	506010607	CYLINDER KPL	GR 41	1
503 44 08-02	503440802	CYLINDER KPL	GR 41/RS 44	1
725 52 91-56	725529156	SKRUV IHSCM		1

F

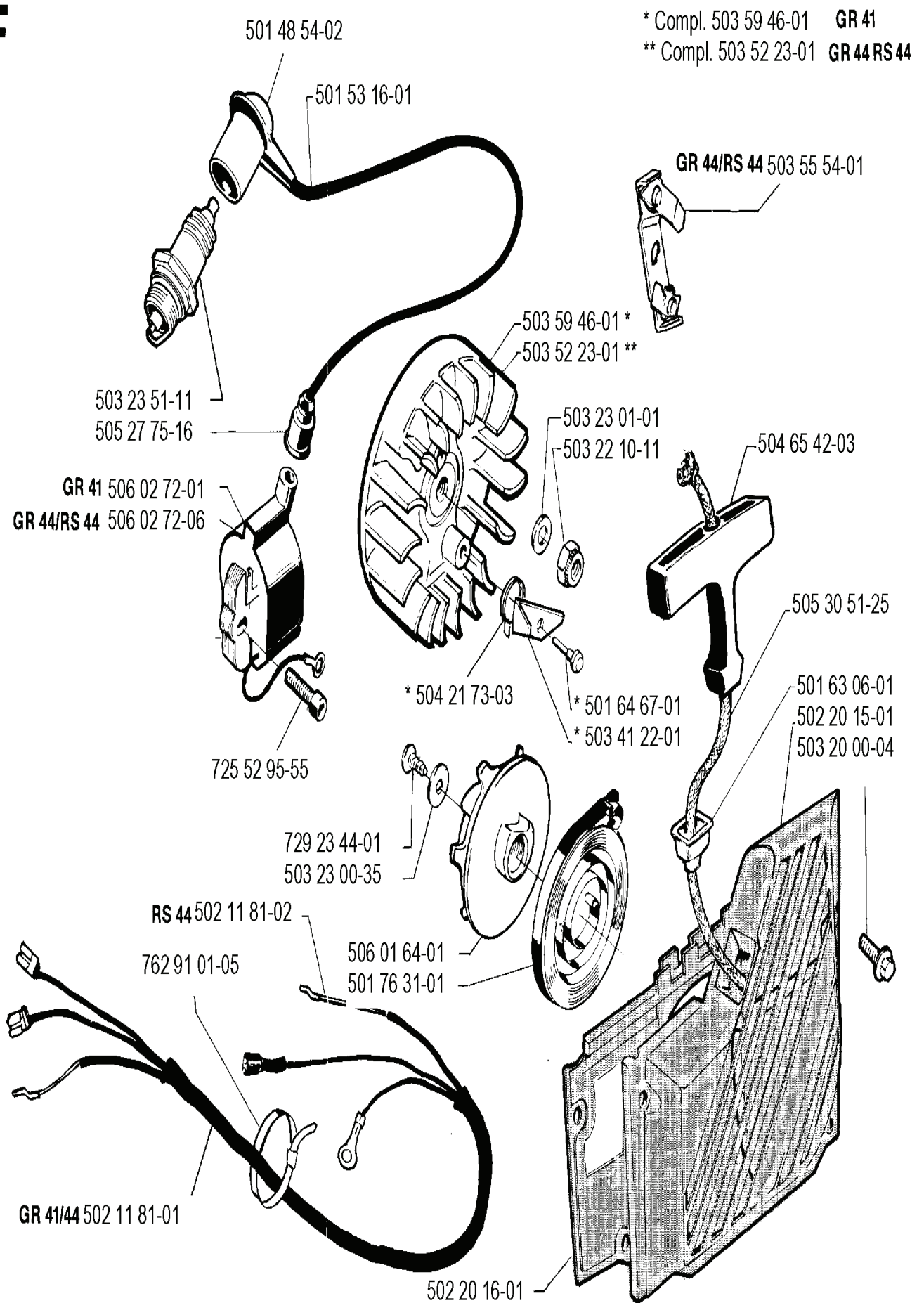

REF.	ART. NR	ARTIKELBESKRIVNING	ANMÄRKNING	KIT
501 48 54-02	501485402	TÄNDSTIFTSSKYDD		1
501 53 16-01	501531601	KABEL		1
503 23 51-11	503235111	TÄNDSTIFT		1
505 27 75-16	505277516	SLADDHYLSA		1
506 02 72-01	506027201	ELECTRONIC MODULE	GR 41	1
506 02 72-06	506027206	ELECTRONIC MODULE	GR 44/RS 44	1
725 52 95-55	725529555	SKRUV IHSCM		1
502 11 81-02	502118102	KABLAGE KPL	RS 44	1
762 91 01-05	762910105	HOOP		1
502 11 81-01	502118101	KABLAGE KPL	GR 41/44	1
502 20 16-01	502201601	LUFTLEDARE		1
501 76 31-01	501763101	FJÄDERKASSETT KPL		1
506 01 64-01	506016401	LINHJUL		1
503 23 00-35	503230035	BRICKA		1
729 23 44-01	729234401	SKRUV SLPANT		1
504 21 73-03	504217303	FJÄDER		1
503 59 46-01	503594601	SVÄNGHJUL KPL	GR 41	1
503 52 23-01	503522301	SVÄNGHJUL	GR 44 RS 44	1
503 23 01-01	503230101	BRICKA		1
503 22 10-11	503221011	MUTTER (HEXAGON)		1
501 64 67-01	501646701	TAPP STARTHAKE		1
503 41 22-01	503412201	STARTHAKE		1
503 20 00-04	503200004	SKRUV EHHFM		1
502 20 15-01	502201501	STARTAPPARATUS		1
501 63 06-01	501630601	HYLSA		1
505 30 51-25	505305125	STARTSNÖRE		1
504 65 42-03	504654203	STARTHANDTAG		1
503 55 54-01	503555401	STARTER PAWL BRIDGE	GR 44/RS 44	1

B

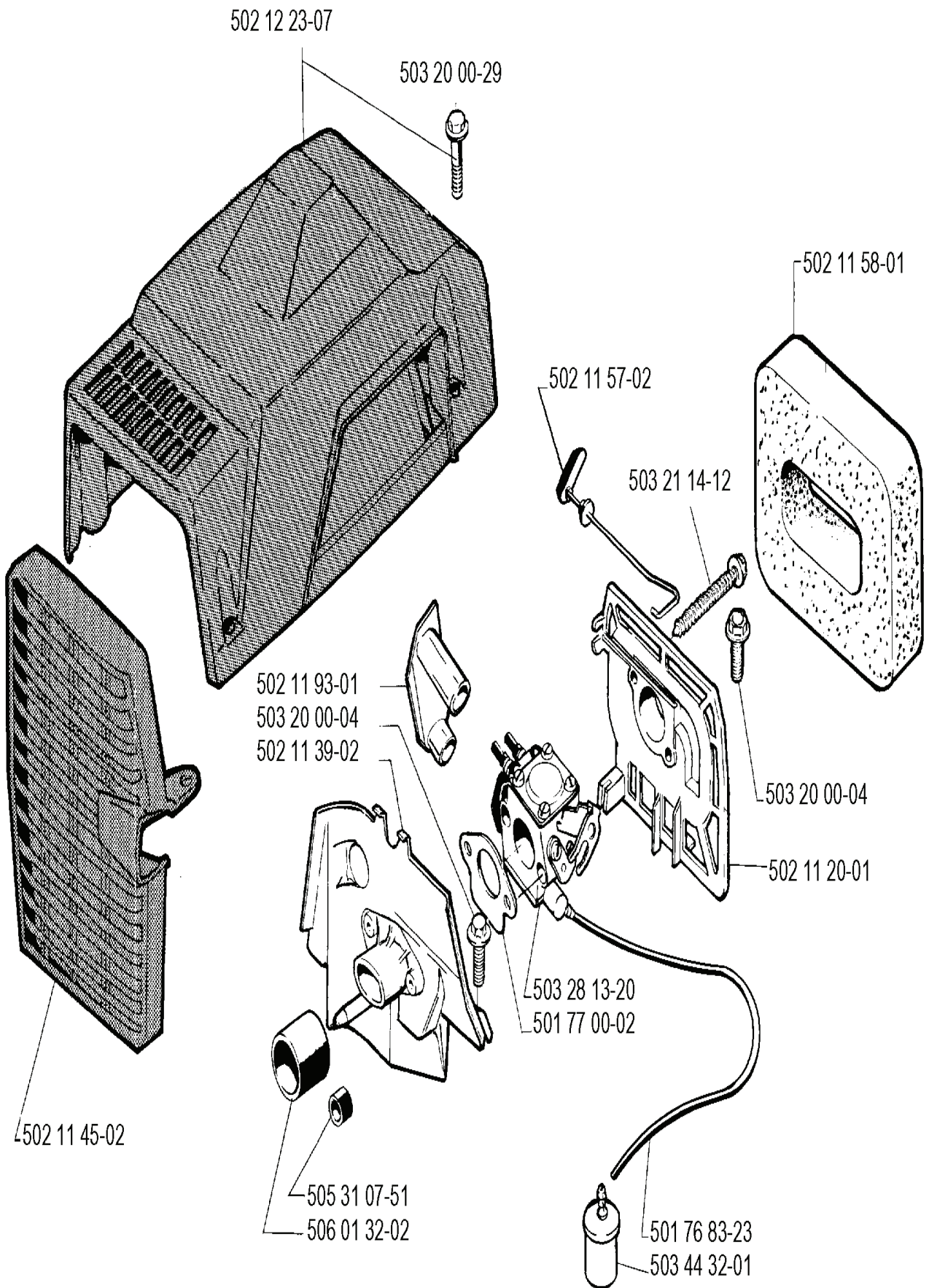

REF.	ART. NR	ARTIKELBESKRIVNING	ANMÄRKNING	KIT
502 12 23-07	502122307	CYLINDERKÅPA KPL		1
502 11 93-01	502119301	STYRHYLSA		1
503 20 00-04	503200004	SKRUV EHHFM		1
502 11 39-02	502113902	MELLANVÄGG		1
502 11 45-02	502114502	VÄRMESKYDD		1
506 01 32-02	506013202	INSUGSRÖR		1
505 31 07-51	505310751	IMPULSSLANG		1
503 44 32-01	503443201	BRÄNSLEFILTER		1
501 76 83-23	501768323	BRÄNSLESLANG		1
501 77 00-02	501770002	PACKNING		1
503 28 13-20	503281320	FÖRGASARE		1
502 11 20-01	502112001	FILTERHÅLLARE		1
503 21 14-12	503211412	SKRUV EHHFT		1
502 11 57-02	502115702	CHOKEREGLAG		1
502 11 58-01	502115801	LUFTFILTER		1
503 20 00-29	503200029	SKRUV EHHFM		1

C

* Compl. 502 26 10-01

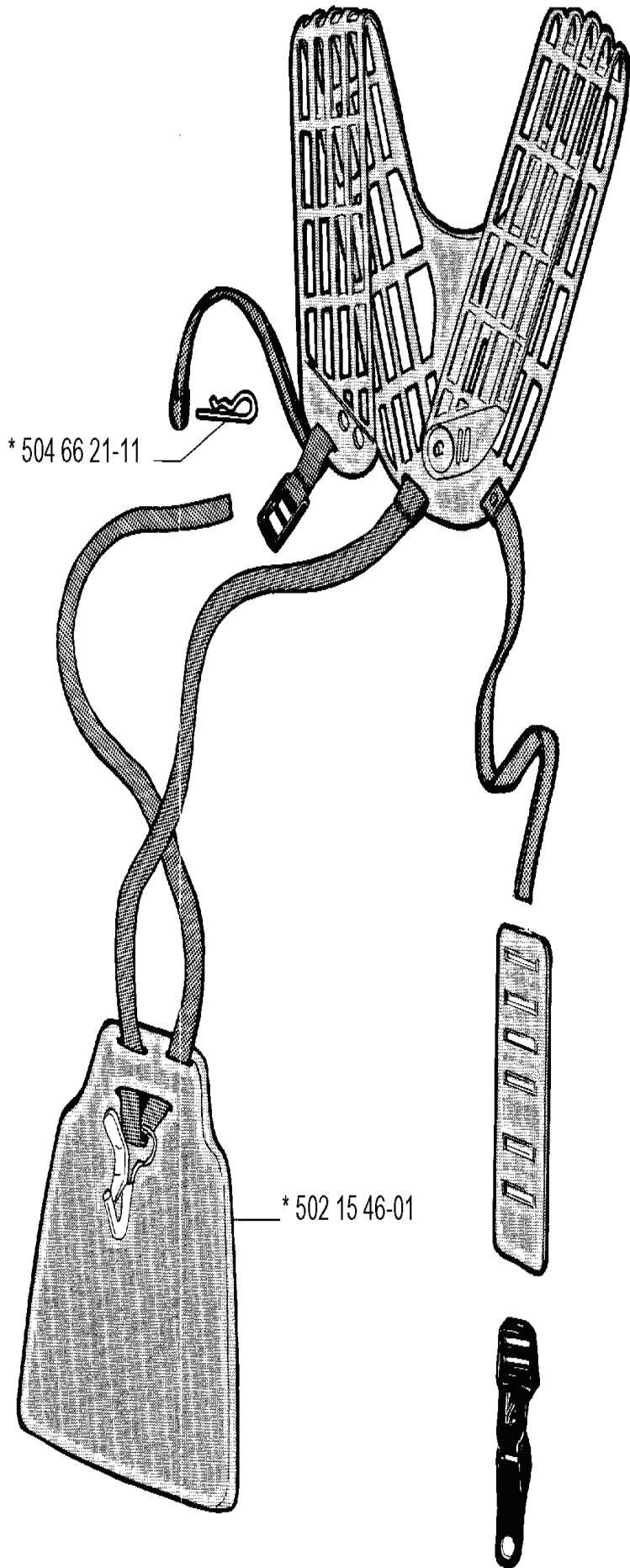

REF.	ART. NR	ARTIKELBESKRIVNING	ANMÄRKNING	KIT
504 66 21- 11	504662111	HAIR PIN COTTER		1
502 15 46- 01	502154601	HÖFTPUTA		1
502 26 10- 01	502261001	SELE		1

H



502 20 51-01



502 20 52-01



502 20 53-01

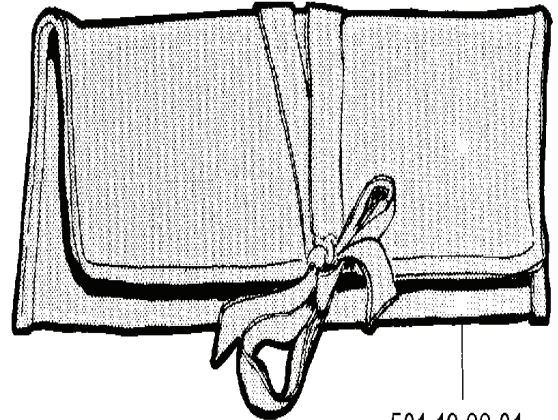

501 19 22-01

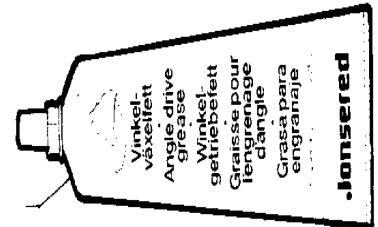

504 98 00-20



503 50 23-01

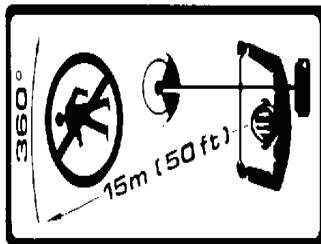

503 50 69-01

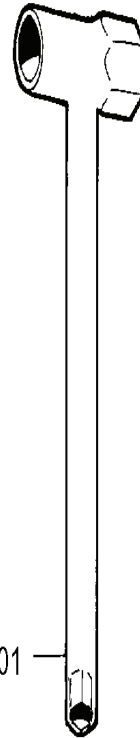

502 11 46-01



502 02 61-02



501 60 02-02

REF.	ART. NR	ARTIKELBESKRIVNING	ANMÄRKNING	KIT
502 20 51-01	502205101	DEKAL	GR 41	1
502 20 52-01	502205201	DEKAL	GR 44	1
502 20 53-01	502205301	DEKAL	RS 44	1
503 50 23-01	503502301	DEKAL		1
503 50 69-01	503506901	DEKAL		1
502 11 46-01	502114601	HYLSNYCKEL		1
502 02 61-02	502026102	STOPP		1
501 60 02-02	501600202	SKRUVMEJSEL		1
504 98 00-20	504980020	FETT		1
501 19 22-01	501192201	VERKTYG		1

G

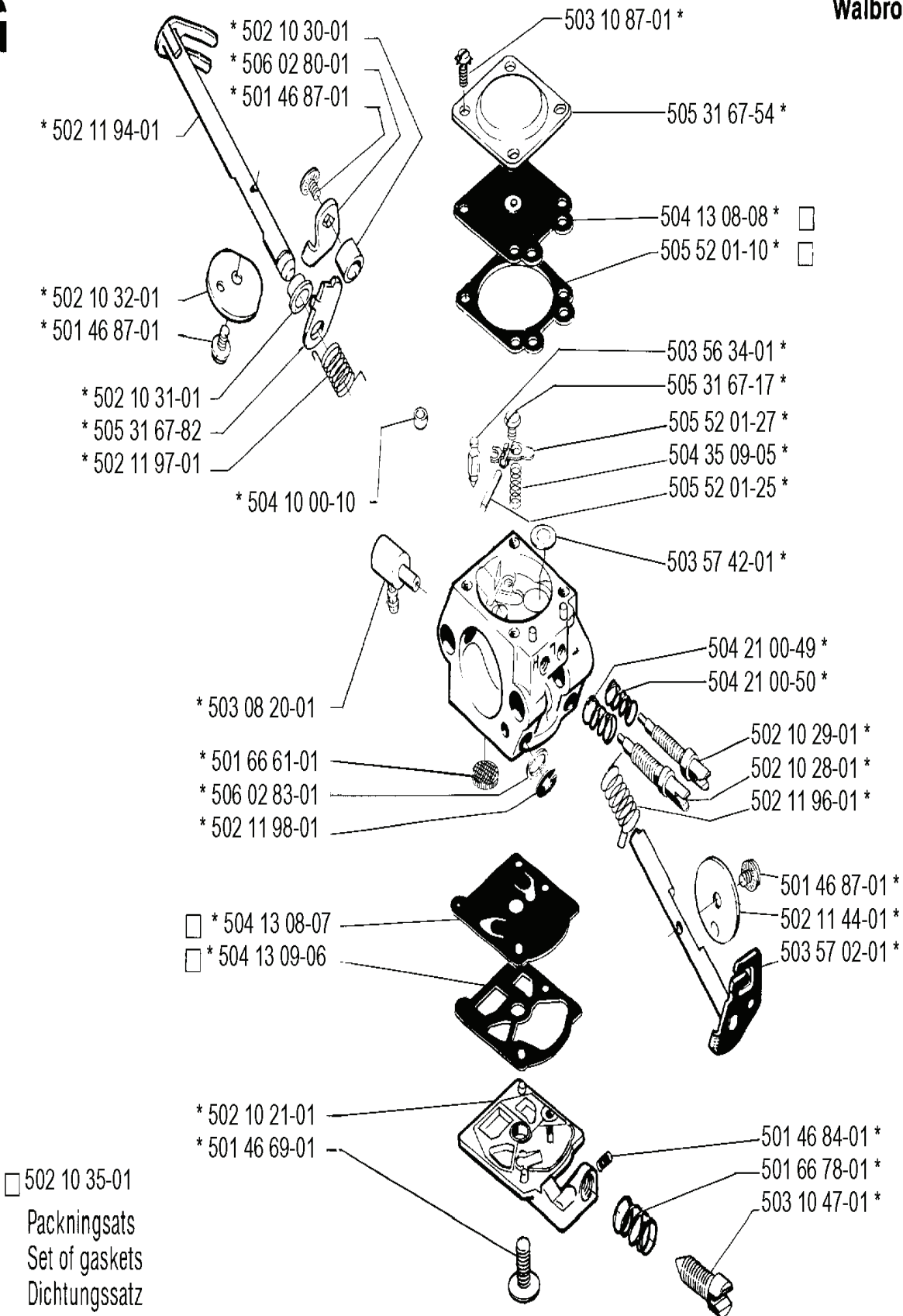

□ 502 10 35-01
 Packningsats
 Set of gaskets
 Dichtungssatz
 Jeu de joints
 Juego de Juntas

* Compl. 503 28 13-20

REF.	ART. NR	ARTIKELBESKRIVNING	ANMÄRKNING	KIT
502 10 30-01	502103001	DISTANS		1
506 02 80-01	506028001	STARTGASARM		1
502 11 94-01	502119401	CHOKEAXEL		1
502 10 32-01	502103201	CHOKE SKIVA		1
502 10 31-01	502103101	BUSHING		1
505 31 67-82	505316782	HÄVARM		1
502 11 97-01	502119701	RETURFJÄDER		1
504 10 00-10	504100010	PLUGG		1
503 08 20-01	503082001	FITTING		1
501 66 61-01	501666101	NÄT		1
506 02 83-01	506028301	BRICKA		1
502 11 98-01	502119801	SPÄRRING		1
504 13 08-07	504130807	DIAPHRAGM PUMP	502 10 35-01 SET OF GASKETS	1
504 13 09-06	504130906	PACKNING	502 10 35-01 SET OF GASKETS	1
502 10 21-01	502102101	LOCK PUMPSIDA		1
501 46 69-01	501466901	SCREW		1
503 28 13-20	503281320	FÖRGASARE		1
503 10 47-01	503104701	SCREW		1
501 66 78-01	501667801	FJÄDER		1
501 46 84-01	501468401	FJÄDER		1
503 57 02-01	503570201	AXEL KPL		1
502 11 44-01	502114401	TROTTELSKIVA		1
501 46 87-01	501468701	SCREW		1
502 11 96-01	502119601	RETURFJÄDER		1
502 10 28-01	502102801	HIGH SPEED NEEDLE		1
502 10 29-01	502102901	LOW SPEED NEEDLE		1
504 21 00-50	504210050	FJÄDER		1
504 21 00-49	504210049	FJÄDER		1
503 57 42-01	503574201	PLUGG		1
505 52 01-25	505520125	TAPP		1
504 35 09-05	504350905	FJÄDER		1
505 52 01-27	505520127	HÄVARM		1
505 31 67-17	505316717	SCREW		1
503 56 34-01	503563401	NÅLVENTIL		1
505 52 01-10	505520110	PACKNING	502 10 35-01 SET OF GASKETS	1
504 13 08-08	504130808	MEMBRAN	502 10 35-01 SET OF GASKETS	1
505 31 67-54	505316754	LOCK STYRMEMBRAN		1
503 10 87-01	503108701	SCREW		1

A

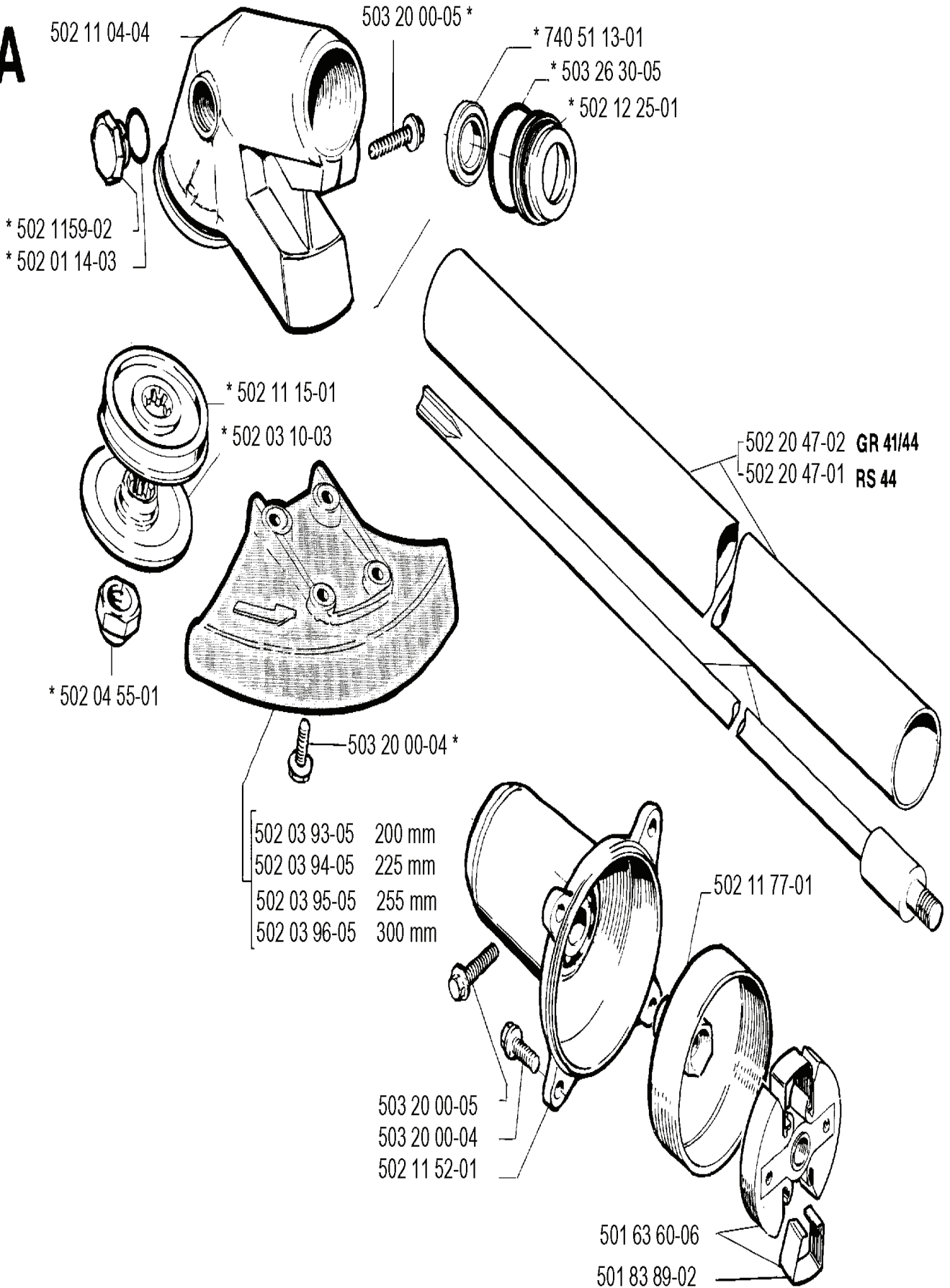

*Compl. 502 11 04-04

REF.	ART. NR	ARTIKELBESKRIVNING	ANMÄRKNING	KIT
502 1159-02	502115902	PLUGG		1
502 01 14-03	502011403	PACKNING		1
502 04 55-01	502045501	MUTTER		1
502 11 04-04	502110404	VÄXELHUS KPL		1
502 03 96-05	502039605	KLINGSKYDD	300 MM	1
502 03 95-05	502039505	KLINGSKYDD	255 MM	1
502 03 94-05	502039405	SAW BLADE GUARD	225 MM	1
502 03 93-05	502039305	KLINGSKYDD	200 MM	1
502 03 10-03	502031003	STÖDFLÄNS		1
502 11 15-01	502111501	MEDBRINGARE		1
503 20 00-04	503200004	SKRUV EHHFM		1
503 20 00-05	503200005	SKRUV EHHFM		1
502 11 52-01	502115201	KOPPLINGSKÅPA KPL		1
501 83 89-02	501838902	KOPPLINGSFJÄDER		1
501 63 60-06	501636006	KOPPLING KPL		1
502 11 77-01	502117701	KOPPLINGSTRUMMA KPL		1
502 20 47-01	502204701	RIGGRÖR	RS 44	1
502 20 47-02	502204702	RIGGRÖR	GR 41/44	1
502 12 25-01	502122501	SEALING HOLDER		1
503 26 30-05	503263005	O-RING		1
740 51 13-01	740511301	SEALING RING		1

I

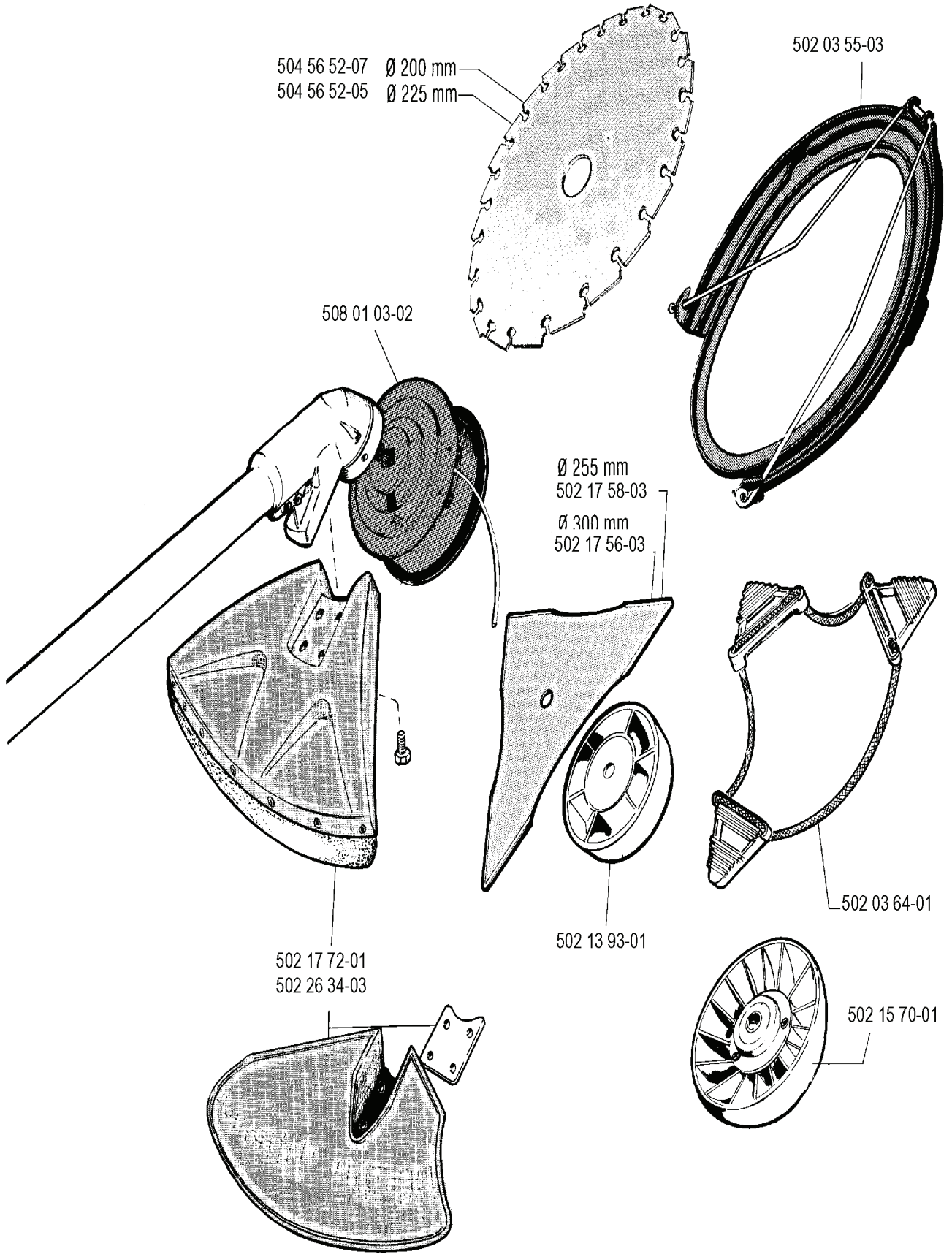

REF.	ART. NR	ARTIKELBESKRIVNING	ANMÄRKNING	KIT
5045652-07	504565207	RÖJKLINGA 200 MM	DIA. 200 MM	1
5045652-05	504565205	RÖJKLINGA 225 MM.	DIA. 225 MM	1
5080103-02	508010302	TRIMMERHUVUD		1
5021772-01	502177201	SPRUTSKYDD KPL		1
5022634-03	502263403	SPRUTSKYDD		1
5021393-01	502139301	STÖDKOPP		1
5021570-01	502157001	STÖDKOPP		1
5020364-01	502036401	TRANSPORTSKYDD		1
5021756-03	502175603	GRASS KNIFE	DIA. 300 MM	1
5021758-03	502175803	GRÄSKNIV	DIA. 255 MM	1
5020355-03	502035503	TRANSPORTSKYDD		1